

UNITED STATES DISTRICT COURT
SOUTHERN DISTRICT OF NEW YORK

----- X
UNITED STATES OF AMERICA,

Plaintiff,

v.

LINCOLN CENTER FOR THE PERFORMING
ARTS, INC.,

Defendant.
----- X

ECF CASE

CONSENT DECREE

12 Civ. 5030 (CM)

WHEREAS, Plaintiff United States of America (the "Government") commenced this action to assure compliance with provisions of the Americans with Disabilities Act of 1990 ("ADA") against defendant Lincoln Center for the Performing Arts, Inc. ("Lincoln Center"), pursuant to 42 U.S.C. § 12188(b)(1)(B), with respect to Avery Fisher Hall, a theater or other place of exhibition or entertainment, located at Lincoln Center, New York, New York 10023; and

WHEREAS, Avery Fisher Hall was built in 1962 as one of the three principal venues at New York's world-renowned Lincoln Center, and is owned and operated by Lincoln Center, a not-for-profit corporation under the laws of the State of New York; and

WHEREAS, the complaint alleges that Lincoln Center violated Title III of the ADA, 42 U.S.C. §§ 12181-89, and the Department of Justice's implementing regulation, 28 C.F.R. Pt. 36, by, among other things, failing to remove architectural barriers to access where it was readily achievable to do so and failing to use readily achievable alternatives to barrier removal where barrier removal was not readily achievable; and

WHEREAS, the United States Attorney's Office for the Southern District of New York conducted an investigation into a complaint alleging lack of certain accessible facilities at Avery Fisher Hall;

WHEREAS, Lincoln Center has cooperated fully with the Government's investigation and shall continue to work cooperatively with the Government to ensure accessibility at Avery Fisher Hall pursuant to the terms of this Consent Decree and Lincoln Center's obligations under the ADA and its implementing regulations;

WHEREAS, after the Government commenced its investigation and prior to the entry of this Consent Decree, Lincoln Center has made the following modifications to elements found to be inaccessible to bring them into compliance with the 2010 ADA Standards for Accessible Design, as defined in 28 C.F.R. § 36.104 (the "Standards"):

- a. Grand Promenade/Orchestra Level – Main Women's Room: The door to the accessible stall has been made self-closing. Standards § 604.8.1.2. The door to the accessible stall has been re-hung to provide proper maneuvering clearances. Standards § 404.2.4.1 & fig. 404.2.4.1(a).
- b. Grand Promenade/Orchestra Level – Northwest Women's Room: Modifications have been made to the accessible stall so that the door does not intrude into the clear floor space in accordance with Section 604.8.1.2 of the Standards.
- c. Grand Promenade/Orchestra Level – Northeast Women's Room: The door to the ambulatory stall has been made self-closing. Standards § 604.8.1.2. A full-length reflective mirror has been added in accordance with Section 603.3 of the Standards.

NOW, THEREFORE, IT IS ORDERED, ADJUDGED AND DECREED as follows:

JURISDICTION AND VENUE

1. This Court has jurisdiction over this action pursuant to 42 U.S.C. §§ 12188(b)(1)(B) and 42 U.S.C. §§ 1331 and 1345.

APPLICATION AND PARTIES BOUND

2. This Consent Decree applies to, and is binding upon, the Government and the Lincoln Center, and their agents and employees. In the event Lincoln Center seeks to transfer or assign all or part of its interest in any facility covered by this agreement, and the successor or assign intends on carrying on the same or similar use of the facility, as a condition of transfer, Lincoln Center shall obtain the written accession of the successor or assign to any obligations remaining under this agreement for the remaining term of this agreement, as defined by paragraph 24 (the "Term") herein. The undersigned representative of Lincoln Center certifies that she is authorized by Lincoln Center to enter into and consent to the terms and conditions of the Consent Decree and to execute and legally bind Lincoln Center to it.

3. Avery Fisher Hall is a place of public accommodation within the meaning of 42 U.S.C. § 12181(7) because it is a "theater, . . . or other place of exhibition or entertainment" within the meaning of 42 U.S.C. § 12181(7)(C) and 28 C.F.R. § 36.104. Lincoln Center operates a place of public accommodation as defined in 42 U.S.C. § 12181 and 28 C.F.R. § 36.104, and is thus a public accommodation subject to the requirements of the ADA.

FACILITY COVERED BY THIS CONSENT DECREE

4. This Consent Decree shall apply to the theater facilities at Avery Fisher Hall, Lincoln Center, New York, New York, and to the specific elements of the "Yellow" parking garage at Lincoln Center which are solely under Lincoln Center's control and which are described

in paragraph 16 below. Notwithstanding any term of this Consent Decree, specifically reserved and excluded from the scope and terms of this Consent Decree as to any entity or person, including the Government, is any claim arising under the ADA and the Department of Justice regulations implementing the ADA pertaining to the below stage, below- or above-stage dressing and wardrobe rooms, security and other offices, toilet facilities in these areas, or the routes to and connecting these areas, or to the elements of the parking garage at Lincoln Center not addressed herein.

INJUNCTIVE RELIEF

BARRIERS TO ACCESS

5. During the course of its investigation of Avery Fisher Hall, the Government identified barriers to access to and within Avery Fisher Hall, which are described more fully below. Lincoln Center shall remedy the barriers to access identified in this Consent Decree in the manner set forth below within twelve (12) months after the date of entry of this Consent Decree with respect to the items set forth in paragraphs 10(a)-(f), 12, 14, and 16(a), within eighteen (18) months after the date of entry of this Consent Decree with respect to the items set forth in paragraphs 7, 10(g) and 16(b). In addition, any renovations or alterations to Avery Fisher Hall, within the meaning of 28 C.F.R. § 36.402, shall be made in accordance with the Standards, including without limitation the addition of new seating, restaurant, function room, toilet room, drinking fountain, public telephone, or bar, food or other retail concessions or facilities.

**DESIGNATED WHEELCHAIR AND COMPANION SEATING
AND AISLE TRANSFER SEATING**

6. Barrier Description: Avery Fisher Hall has a maximum seating capacity of 2,738 people. The Standards require six wheelchair seating locations for assembly areas that can

accommodate 500 seated individuals, and additional wheelchair seating locations as the theater capacity increases. *See* Standards tbl. 221.2.1.1. To the extent that it is readily achievable, these seats shall be dispersed and shall provide comparable lines of sight and be offered at comparable ticket prices. 28 C.F.R. §§ 36.308, 36.302(f)(3), 36.406(f)(2); Standards §§ 221.2.3, 802.2. The Standards also require that at least one companion seat be provided next to each wheelchair seat with shoulder alignment and equal size, quality, comfort, and amenities to nearby seating. *See* Standards §§ 221.3, 802.3. The Standards further provide that at least five percent of the aisle seats shall be designated aisle transfer seats. *See* Standards §§ 221.4, 802.4. Annexed hereto as Exhibit A, is a copy of Lincoln Center's current Seating Plan for Accessibility ("Current Seating Plan").

7. Consent Decree Requirement: Within eighteen months of the date of entry of this Consent Decree, Lincoln Center agrees to alter the Current Seating Plan to provide for five additional wheelchair seating locations in the Orchestra Level of Avery Fisher Hall's assembly area, each such seating location to be accompanied by a designated companion seat. Four of these additional wheelchair seating locations and designated companion seats shall be located in an area near Rows M-O of the center seating section as depicted in Exhibit B, and one additional wheelchair seating location and companion seat shall be located in an area near Row QQ of the side seating section as depicted in Exhibit C (Exhibits A, B and C, collectively, the "Revised Seating Plan"). The wheelchair seating locations depicted in the Current Seating Plan (*i.e.*, Exhibit A) shall remain otherwise unaltered. Lincoln Center also agrees to add sixteen modified aisle transfer seats in the Orchestra Level. Lincoln Center agrees to designate sufficient staff members to assist individuals using the wheelchair seating locations depicted in Exhibit B who require help to traverse the slope of the aisles. Lincoln Center agrees that tickets for wheelchair

and companion seating locations at Avery Fisher Hall shall be offered for sale in compliance with 28 C.F.R. § 36.302(f).

8. Lincoln Center further agrees that before commencing any physical alteration to the seating depicted in the Revised Seating Plan during the Term hereof, within the meaning of 28 C.F.R. § 36.402, Lincoln Center shall provide the Government with a Proposed Seating Plan for Accessibility (“Proposed Seating Plan”), which shall not contain fewer accessible seating locations than those designated in the Revised Seating Plan, and shall otherwise comply with the ADA Standards. Lincoln Center shall obtain the Government’s approval, which shall not be unreasonably withheld, before commencing any renovation pursuant to any Revised Seating Plan during the Term hereof, as defined by paragraph 24.

TOILET ROOMS

9. Barrier Description: Water closets, urinals, lavatories and doors contain non-accessible elements that are not compliant with the 1991 ADA Standards for Accessible Design (“1991 Standards”). In addition, there are protruding objects and inaccessible signage, sinks and mirrors that are not compliant with the 1991 Standards.

10. Consent Decree Requirement: With the exception of the requirement set forth in paragraph 10(g) below, within twelve months of the entry of this Consent Decree, Lincoln Center shall make the following alterations to the toilet rooms to comply with the Standards:

- a. Plaza Level Men’s Room: The urinal shall be lowered to comply with Section 605.2 of the Standards.
- b. Plaza Level Men’s and Women’s Rooms: Room identification signs shall be repositioned to comply with Section 703.4.1 of the Standards.

- c. Grand Promenade/Orchestra Level – Main Women’s Room: The lavatory shall be raised to comply with the knee clearance requirements of Section 306.3 of the Standards. The water closet in the accessible stall shall be raised so that the height of the seat complies with Section 604.4 of the Standards.
- d. Grand Promenade/Orchestra Level – Northwest Women’s Room: The water closet in the accessible stall shall be raised so that the height of the seat complies with Section 604.4 of the Standards. Room identification signage shall be added in compliance with Sections 216.2 and 703 of the Standards. Modifications shall be made in the accessible stall so that the toilet centerline complies with Section 604.2 of the Standards. The lavatory shall be raised to comply with the knee clearance requirements of Section 306.3 of the Standards.
- e. Grand Promenade/Orchestra Level – Men’s Room: An accessible urinal shall be installed in compliance with Section 605.2 of the Standards. The accessible urinal shall have an automatic flush control or, if a hand-operated flush control is used, it shall be within 48 inches of the finish floor, shall be operable with one hand and shall not require tight grasping, pinching or twisting of the wrist. Standards §§ 308.2, 309.4, 605.4. Modifications shall be made in the accessible stall so that the height of the seat of the water closet complies with Section 604.4 of the Standards and so that the door does not intrude into the clear floor space as required by Section 604.8.1.2 of the Standards.

- f. Unisex Room: Room identification signage shall be added in compliance with Sections 216.2 and 703 of the Standards. A cane detectable barrier shall be added under the end of the sanitary napkin dispenser as required under Section 307.2 of the Standards.
- g. First, Second and Third Tiers: Within eighteen months of the entry of this Consent Decree, one accessible Men's and Women's toilet room, or one unisex toilet room, shall be added on each of the three Tiers and shall comply with the 2010 Standards.

GENERAL AREAS

11. Barrier Description: Doors, drinking fountains and public telephones contain non-accessible elements that are not compliant with the 1991 Standards. In addition, there are protruding objects and inaccessible signage that are not compliant with the 1991 Standards.

12. Consent Decree Requirement: Within twelve months of the date of entry of this Consent Decree, Lincoln Center shall make the following alterations in compliance with the Standards:

- a. Grand Promenade: An automatic door opener shall be added for the doors leading to the balcony and shall comply with Section 404.3 of the 2010 Standards. A cane detectable barrier shall be added under the lowered portion of the Assistive Listening Device distribution station so that it does not constitute a protruding object under Section 307.2 of the Standards.
- b. First, Second and Third Tiers: A cane detectable barrier shall be added under the emergency equipment cabinets in the enclosed corridors so that

they do not constitute protruding objects under Section 307.2 of the Standards.

- c. Elevators: The signs on the elevator jambs shall be modified to comply with Section 407.2.3.1 of the Standards.
- d. Helen Huntington Hull Room: The operating mechanism on the door to the Helen Huntington Hull Room shall be replaced with one that does not require tight grasping, tight pinching or twisting of the wrist to operate. Standards § 309.4.
- e. Drinking Fountains: Where drinking fountains are provided, they shall comply with Sections 211 and 602 of the Standards.
- f. Public Telephones: Where public telephones are provided, they shall comply with Sections 217, 308, 309 and 704 of the Standards.

FOOD/DRINK SERVICE AND RETAIL AREAS

13. Barrier Description: Retail counters and table seating contain non-accessible elements that are not compliant with the 1991 ADA Standards for Accessible Design (“1991 Standards”).

14. Consent Decree Requirement: Within twelve months of the date of entry of this Consent Decree, Lincoln Center shall make the following alterations in compliance with the Standards:

- a. Arpeggio Food & Wine: Accessible seating at tables shall be provided in compliance with Sections 226, 305, 306 and 902 of the Standards.
Accessible seating shall be dispersed in the various dining areas. A cane detectable barrier shall be added under the light valance on top of the

partition near the west stairs so that it does not constitute a protruding object under Section 307.2 of the Standards.

- b. Ronnie & Larry Ackerman Patron Lounge: Accessible seating at tables shall be provided in compliance with Sections 226, 305, 306 and 902 of the Standards. The beverage counter shall be lowered to 36 inches above the finish floor in compliance with Section 904.4.1 of the Standards.
- c. Vera & Donald Blinken Patron Lounge: Accessible seating at tables shall be provided in compliance with Sections 226, 305, 306 and 902 of the Standards. The beverage counter shall be lowered to 36 inches above the finish floor in compliance with Section 904.4.1 of the Standards.
- d. Espresso Bar: A cane detectable barrier shall be added under the end of the seating counter at the southwest corner of the Plaza Level so that it does not constitute a protruding object under Section 307.2 of the Standards. An accessible extension to the service counter will be added near the west stairway in compliance with Section 904.4.1 of the Standards.

PARKING

15. Barrier Description: The Lincoln Center garage contains an inadequate number of van accessible parking spaces and noncompliant signage.

16. Consent Decree Requirement:

- a. Within twelve months of the date of entry of this Consent Decree, Lincoln Center shall ensure that all accessible parking signs comply with Section 502.6 of the Standards.

- b. Within eighteen months of the date of entry of this Consent Decree, Lincoln Center shall add one accessible parking location to the Yellow Garage and convert two of the existing accessible parking locations to van accessible parking locations in compliance with the 2010 Standards, except that the van accessible parking locations need not comply with the height requirement set forth in Section 502.5 of the Standards, such compliance being technically infeasible.

GOODS, SERVICES, BENEFITS, ADVANTAGES AND PRIVILEGES

17. Lincoln Center shall not discriminate against individuals on the basis of disability in the full and equal enjoyment of the goods and services at Avery Fisher Hall. Lincoln Center shall provide individuals with disabilities an equal opportunity to benefit from the goods, services, benefits, advantages and privileges as is provided to those individuals without disabilities.

CERTIFICATIONS

18. Within sixty (60) days after the periods set forth for completion of the modifications set forth above – *i.e.*, twelve (12) months after the date of entry of this Consent Decree with respect to the items set forth in paragraphs 10(a)-(f), 12, 14, and 16(a), and eighteen (18) months after the date of entry of this Consent Decree with respect to the items set forth in paragraphs 7, 10(g) and 16(b) – Lincoln Center shall submit to the Government a certification, under penalty of perjury, stating that it has complied with all obligations of this Consent Decree that are required to be satisfied or completed by that date, and shall state specifically that (a) Lincoln Center has maintained the Seating Plan pursuant to paragraph 7; and (b) Lincoln Center has completed the required modifications. Within thirty days after the date of completion of any alteration pursuant to a Proposed Seating Plan under paragraph 7, Lincoln Center shall

submit to the Government a certification, under penalty of perjury, stating that it has complied with all obligations of this Consent Decree as to any Proposed Seating Plan under paragraph 7.

RIGHT TO REVIEW COMPLIANCE

19. Upon reasonable advance notice to Lincoln Center (through undersigned counsel), Lincoln Center shall permit the Government and any person acting on its behalf unrestricted access to Avery Fisher Hall to review compliance with the ADA and this Consent Decree. If the Government believes that Lincoln Center has violated this Consent Decree or is otherwise not in full compliance with the ADA, the United States will notify Lincoln Center in writing and seek to resolve the matter amicably before applying to the Court for relief.

VIOLATION OF THIS CONSENT DECREE

20. A violation of this Consent Decree shall be deemed a subsequent violation of the ADA under 42 U.S.C. § 12188(b)(3); 28 C.F.R. § 36.504(b).

RESERVATION OF RIGHTS

21. Nothing contained in this Consent Decree is intended or shall be construed as an admission by or finding against Lincoln Center that Lincoln Center was in violation of the ADA or any other federal statutes or regulations, or as a waiver by the Government of any right to institute any proceeding or action against Lincoln Center for violations of any statutes, rules or regulations administered by the Government, or to prevent or limit the rights of the Government to obtain relief under the ADA, or any other federal statutes or regulations, or on account of any violation of this Consent Decree or any other provision of law. Notwithstanding the preceding sentence, subject to Lincoln Center's full compliance with the Consent Decree, the Government will not file a subsequent complaint against Lincoln Center pursuant to Title III of the ADA concerning Avery Fisher Hall for the same violations identified in the complaint herein, unless

Lincoln Center makes alterations that do not comply with Title III of the ADA. This Consent Decree is a compromise of claims between the Government and Lincoln Center. It is based on the unique nature of this particular facility and its provisions are not necessarily applicable to any other entities or facilities.

MODIFICATION

22. There shall be no modification of this Consent Decree without the written consent of the Government and Lincoln Center and the approval of the Court.

ENTIRE AGREEMENT

23. This Consent Decree represents the entire agreement between the Government and Lincoln Center. No prior agreements, oral representations or statements shall be considered part of this Consent Decree.

RETENTION OF JURISDICTION

24. This Court shall retain jurisdiction of this action for a period of four (4) years from the date of entry of this Consent Decree, to enforce or modify the provisions of this Consent Decree, to resolve any dispute that arises under this Consent Decree, and to entertain any application and issue any orders (including, without limitation, orders directing the modification of policies, practices, and procedures, and orders requiring the removal of barriers to access) as may be necessary or appropriate for the effectuation of its terms. The parties shall discuss and attempt to negotiate a resolution of any dispute relating to the interpretation of this Consent Decree before bringing the matter to the Court's attention for resolution.

EXECUTION OF CONSENT DECREE

25. This Consent Decree may be executed in counterparts, each of which shall be an original and shall constitute one and the same instrument. Signatures by facsimile or electronic mail shall be accepted as original signatures.

INCORPORATION OF EXHIBITS

26. Exhibits A, B and C to this Consent Decree are incorporated by reference into this Consent Decree as though fully set forth in the Decree.

COSTS AND ATTORNEY'S FEES

27. Each party shall bear its own costs and attorney's fees in this action.

THE PARTIES HEREBY CONSENT to entry of the foregoing Consent Decree:

FOR THE UNITED STATES:

Dated: New York, New York
June 27, 2012

PREET BHARARA
United States Attorney for the
Southern District of New York
Attorney for the United States of America

By:

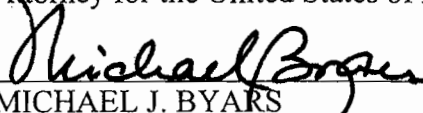
MICHAEL J. BYARS
Assistant United States Attorney
86 Chambers Street -- 3rd Floor
New York, New York 10007
Telephone: (212) 637-2793
Facsimile: (212) 637-2717
E-mail: michael.byars@usdoj.gov

FOR LINCOLN CENTER:

Dated: New York, New York
June 27, 2012

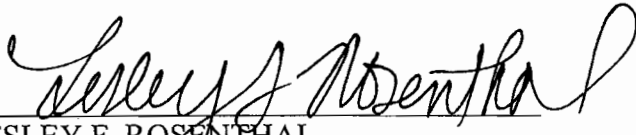
LESLEY F. ROSENTHAL
Vice President, General Counsel & Secretary
Lincoln Center for the Performing Arts, Inc.
70 Lincoln Center Plaza
New York, NY 10023-6583
Telephone: (212) 875-5000
Facsimile: (212) 875-5122
E-mail: counsel@lincolncenter.org

SO ORDERED:



UNITED STATES DISTRICT JUDGE

Exhibit A

Lincoln Center for the Performing Arts
Avery Fisher Hall

Capacity: 2,738

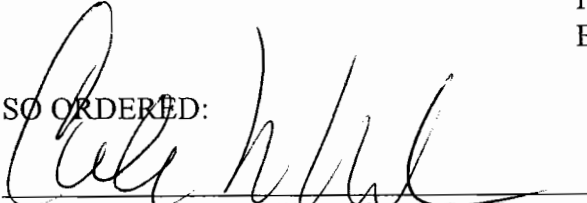
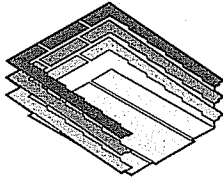

Third Tier
 Capacity: 386

Wheelchair and
 Companion seating:
 DD1, DD2, DD3, DD4,
 DD101, DD102, DD115,
 & DD116

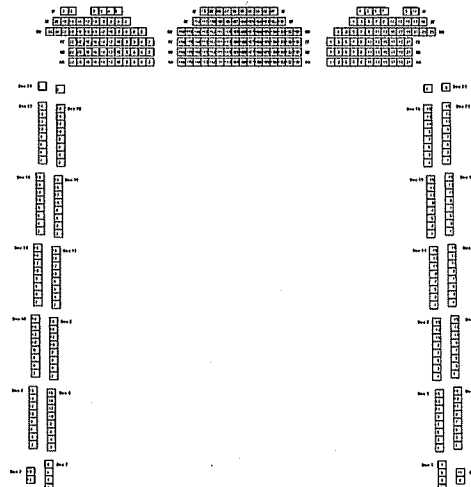

Second Tier
 Capacity: 364

Wheelchair and
 Companion seating:
 DD1, DD2, DD3, DD4,
 DD101, DD102, DD115,
 & DD116

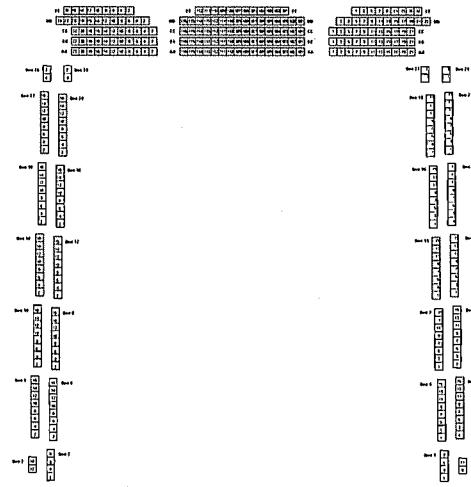

First Tier
 Capacity: 348

Wheelchair and
 Companion seating:
 DD1, DD2, DD3, DD4, DD5,
 DD6, DD101, DD102,
 DD115, & DD116

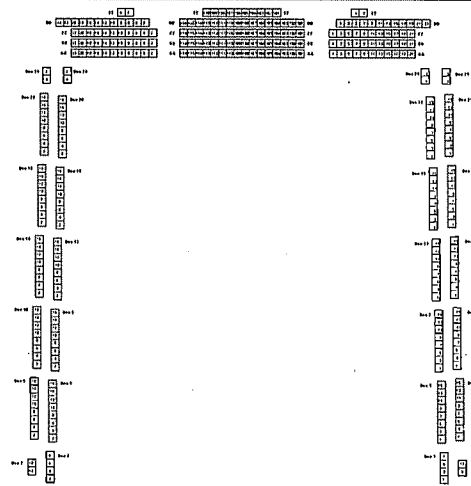

Orchestra
 Capacity: 1640

Wheelchair and
 Companion seating:
 QQ1, QQ2, QQ3, QQ4,
 QQ17, QQ18, QQ19,
 & QQ20

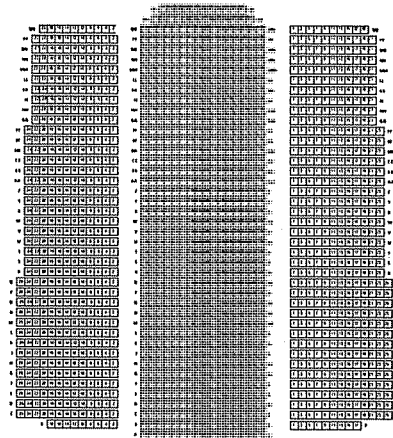
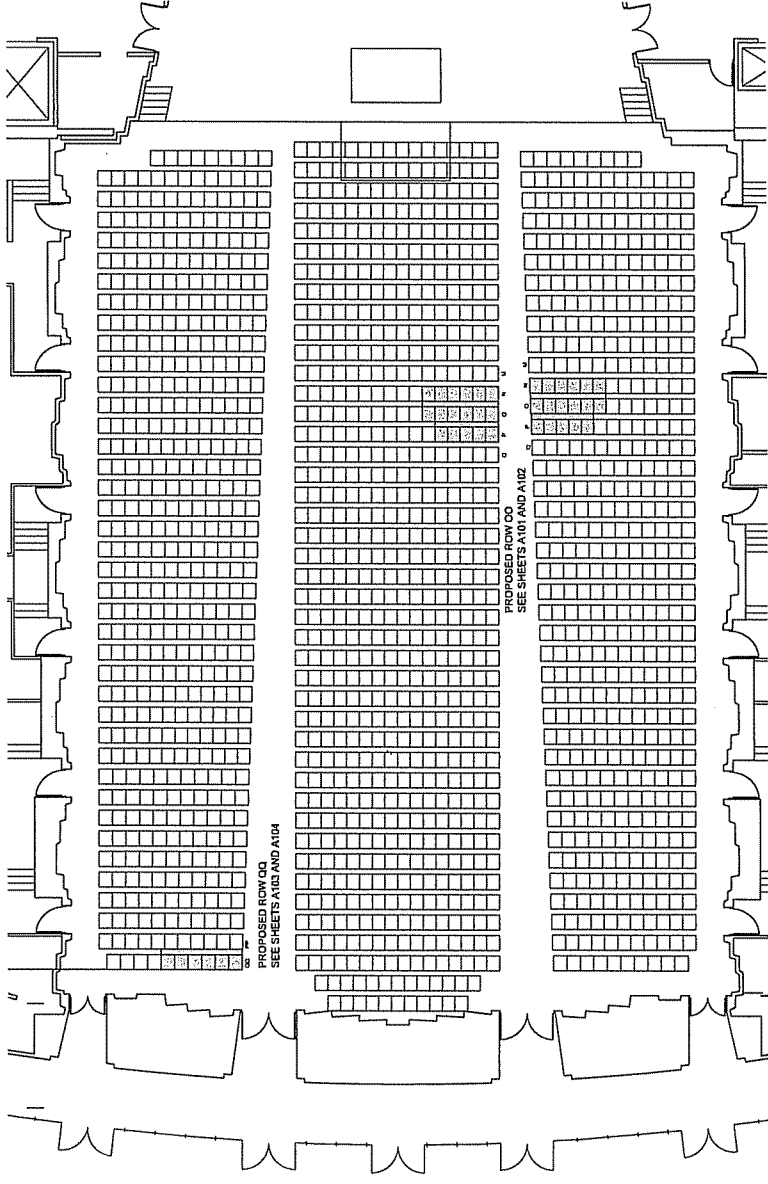

Exhibit B



1 PROPOSED WHEEL CHAIR SEATING AREAS
SCALE: 1/16" = 1'

LINCOLN CENTER FOR THE PERFORMING ARTS
AVERY FISHER HALL - ADA COMPLIANCE

ORCHESTRA LEVEL PLAN
PROPOSED WHEELCHAIR SEATING

DATE: 5/3/12
DRAWN BY: HY
CHK BY: ST
A-100.00
1 of 5

co4architecture.pc 2576 Broadway, New York, NY 10025

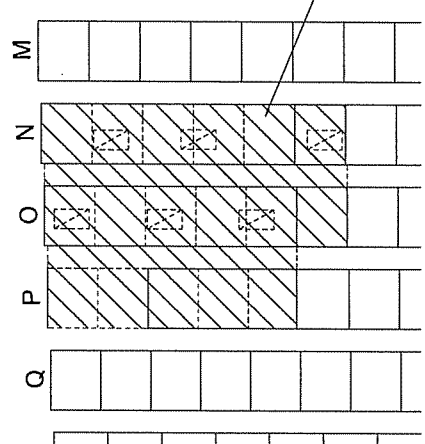
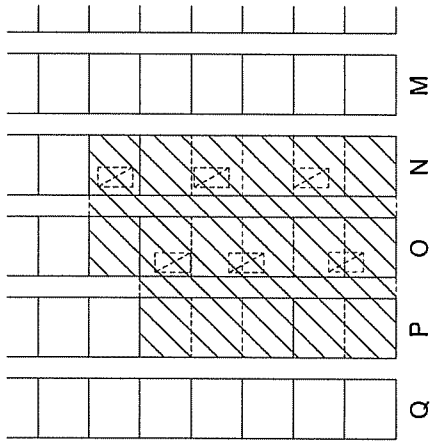

REMOVE EXISTING SEATS AND GRILLES PREP AREA FOR NEW PLATFORM

1 PROPOSED REMOVALS

SCALE: 1/4" = 1'

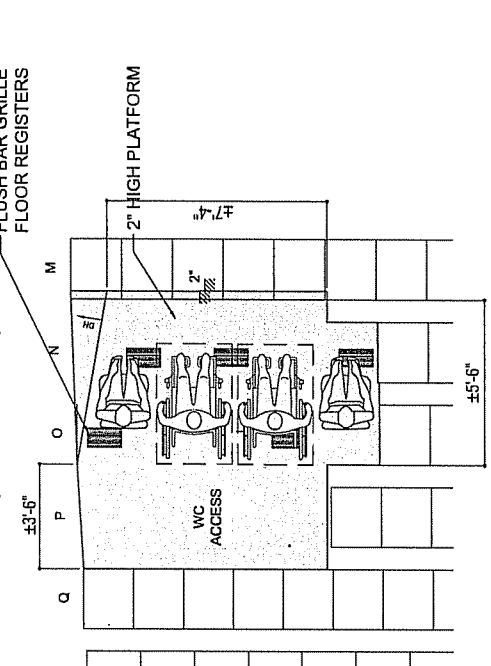
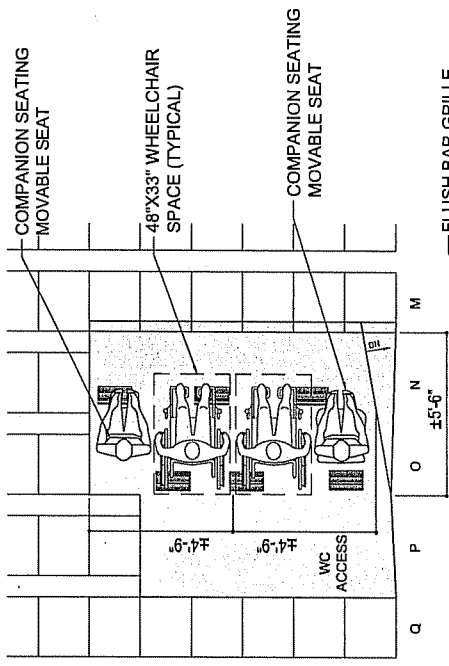

2 PROPOSED PLATFORM PLAN

SCALE: 1/4" = 1'

LINCOLN CENTER FOR THE PERFORMING ARTS
 AVERY FISHER HALL - ADA COMPLIANCE

ORCHESTRA LEVEL PLAN
 PROPOSED WHEELCHAIR SEATING

DATE: 5/3/12
 DRAWN BY: HY
 CHK BY: ST

A-101.00
 2 of 5

co4architecture.pc 2576 Broadway, New York, NY 10025

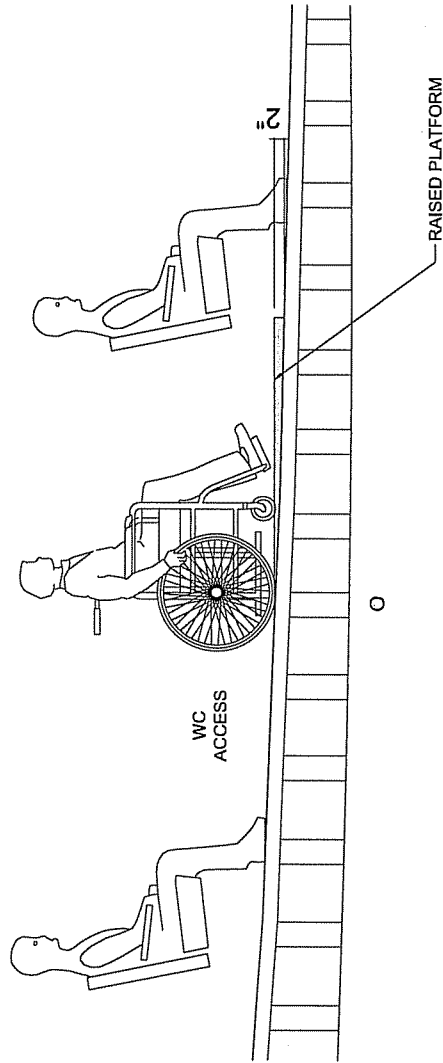

SECTION - ROW O: PROPOSED PLATFORM

1

SCALE: 1/2" = 1'

LINCOLN CENTER FOR THE PERFORMING ARTS
 AVERY FISHER HALL - ADA COMPLIANCE

ORCHESTRA LEVEL PLAN
 PROPOSED WHEELCHAIR SEATING

DATE: 5/3/12
 DRAWN BY: HY
 CHK BY: ST

A-102.00

3 of 5

co4architecture.pc 2576 Broadway, New York, NY 10025

Exhibit C

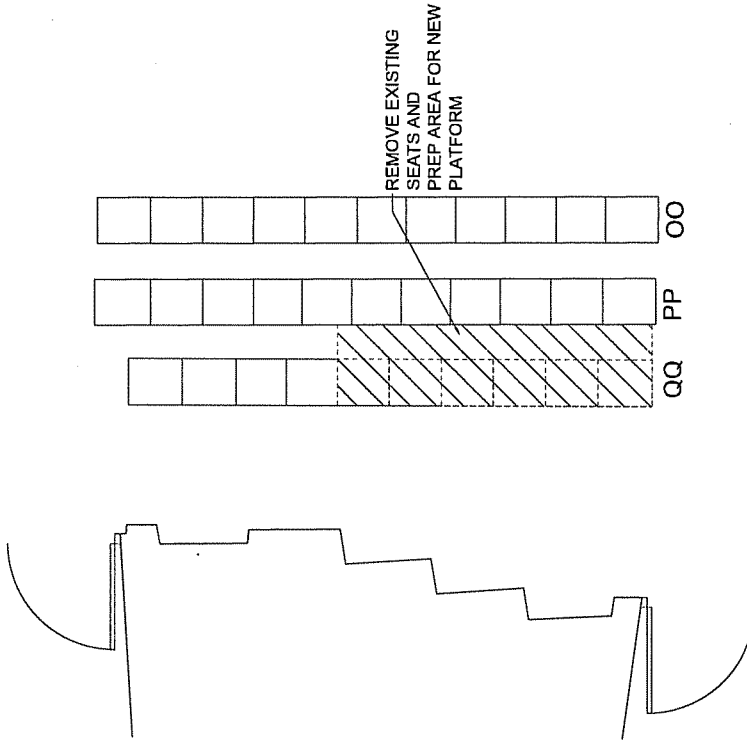
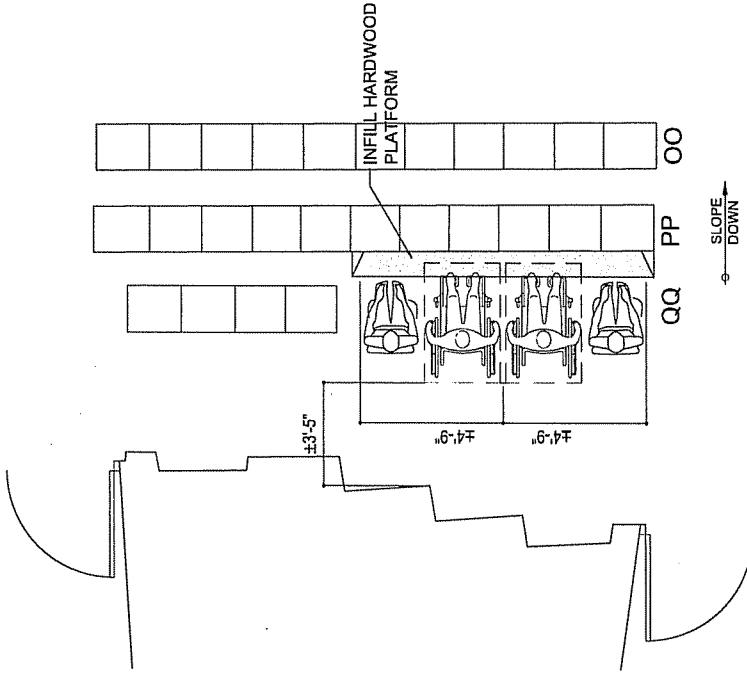

1 PROPOSED REMOVALS
SCALE: 1/4" = 1'

2 PROPOSED PLATFORM PLAN
SCALE: 1/4" = 1'

LINCOLN CENTER FOR THE PERFORMING ARTS
AVERY FISHER HALL - ADA COMPLIANCE

ORCHESTRA LEVEL PLAN
PROPOSED WHEELCHAIR SEATING

DATE: 5/3/12
DRAWN BY: HY
CHK BY: ST
A-103.00
4 of 5

co4architecture.pc 2576 Broadway, New York, NY 10025

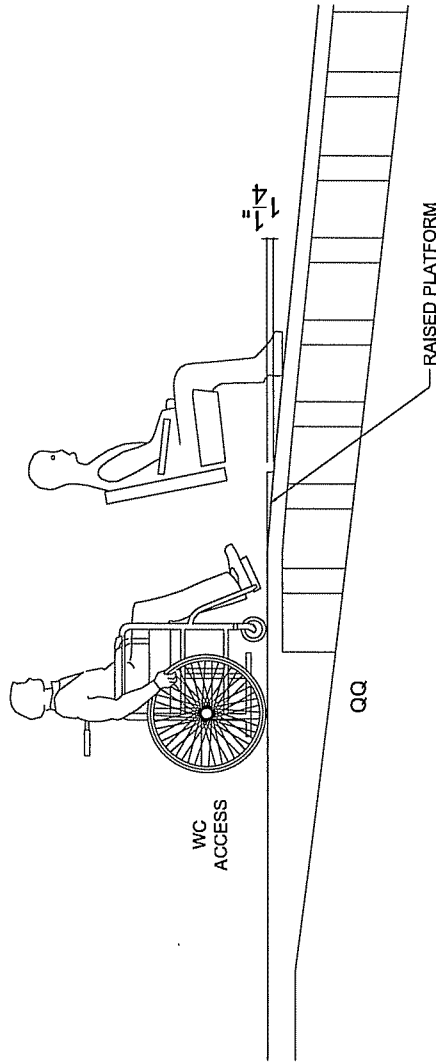

1 SECTION - ROW QQ: PROPOSED PLATFORM

SCALE: 1/2" = 1'

LINCOLN CENTER FOR THE PERFORMING ARTS
 AVERY FISHER HALL - ADA COMPLIANCE

ORCHESTRA LEVEL PLAN
 PROPOSED WHEELCHAIR SEATING

DATE: 5/3/12
 DRAWN BY: HY
 CHK BY: ST
A-104.00
 5 of 5

oo4architecture.pc 2576 Broadway, New York, NY 10025